

BASE AND TRANSPORT PLATE 30X60 M08 CONDUCTIVE

Code: 212114/6

Conductive base plate 30x60 M08 for secure mounting of hinged feet and castors. Ensures safe use in ESD-protected environments.

[Link to the product →](#)

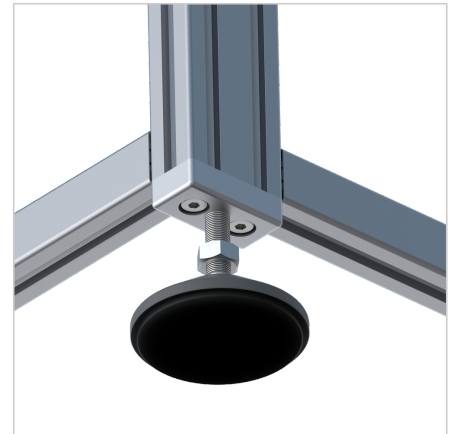
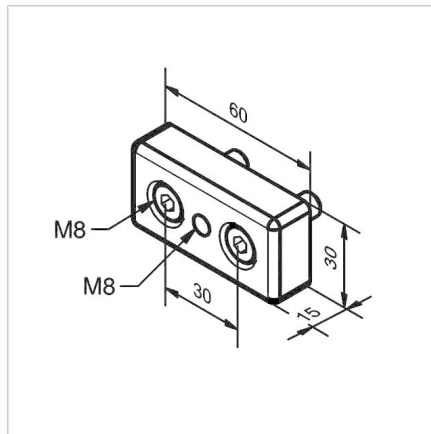

Technical data/items supplied

- Aluminium, Pressure die-casting, blasted
- Fastening kit
- Weight = 0.084 kg/piece

Applications

- Fixing of hinged feet and castors
- Appropriate for ESD implementations

Assembly

- Use fixing material supplied to fix to the end face of the profile