

BASE AND TRANSPORT PLATE 45X90 M16

Code: 211040/0

Conductive base plate 45x90 M16 for mounting hinged feet and wheels on aluminium profiles, providing flexible and stable support for various constructions.

[Link to the product →](#)

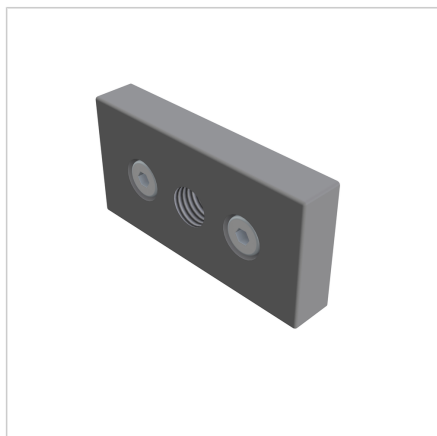

Technical data/items supplied

- Aluminium, Pressure die-casting, powder-coated, grey
- Fastening kit
- Weight = 0.182 kg/piece

Applications

- Centric attachment of hinged feet to profiles 45 x 90

Assembly

- Use fixing material supplied to fix to the end face of the profile