

BASE AND TRANSPORT PLATE 90X90 M20

Code: 211057/0

Base plate 90x90 M20 for mounting hinged feet and wheels on aluminium profiles, providing flexible and stable support for various constructions.

[Link to the product →](#)

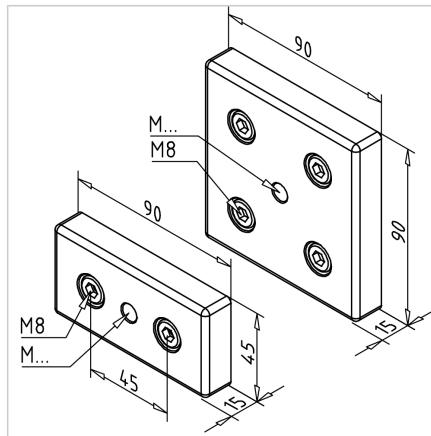
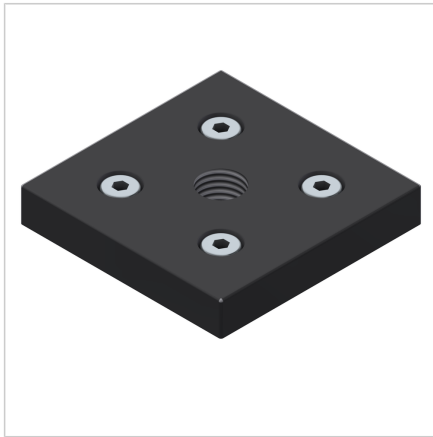

Technical data/items supplied

- Aluminium, Pressure die-casting, powder-coated, grey
- Fastening kit
- Weight = 0.334 kg/piece

Applications

- Centric attachment of hinged feet to profiles 90 x 90

Assembly

- Use fixing material supplied to fix to the end face of the profile