

T-HANDLE 32

Code: 211015/0

[Link to the product →](#)

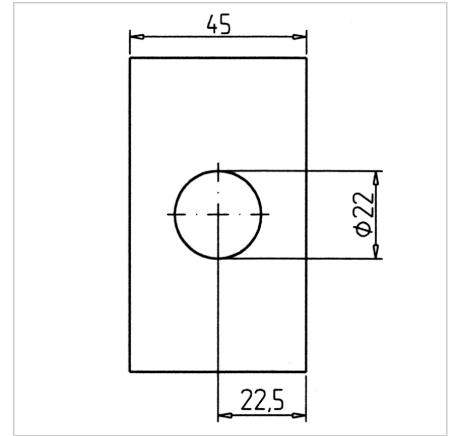
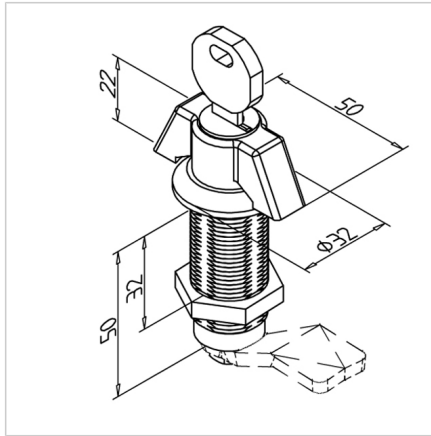

Technical data/items supplied

- Zinc, Pressure die-casting, chromed
- With fastening nut steel, galvanized
- Without locks
- Weight = 0.19 kg/piece

Applications

- For profiles 32
- Locking of doors and lids in guard units

Assembly

- Drill hole \varnothing 22 mm in the centre of the profile recommended: anti-twist protection F part no.. 21.0941/0
- To ensure the torsion protection, a pocket with SW 20.1 mm can alternatively be milled
- Using a ratchet handle, tighten the fastening nut from behind