

BOLT LOCK 45 WITH FOUR-FACED KEY SW 7

Code: 211087/7

Bolt lock 45 with four-faced key for secure locking of guard unit doors made from aluminium profiles.

[Link to the product →](#)

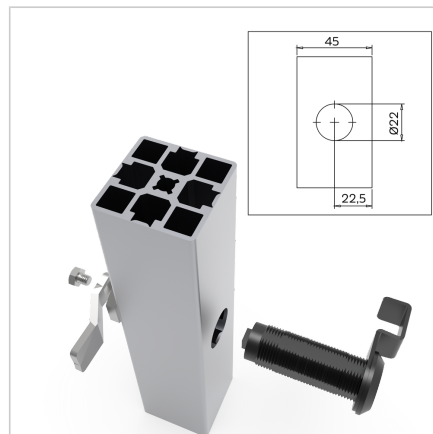
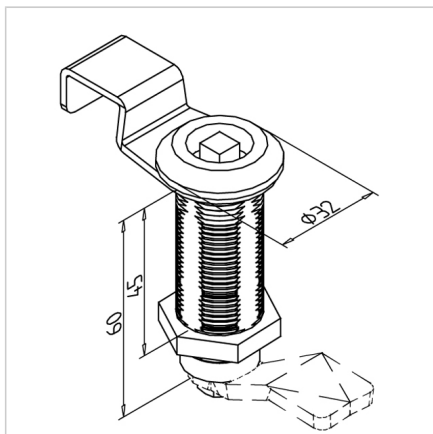

Technical data/items supplied

- Zinc, Pressure die-casting, black
- With square box wrench
- With fastening nut steel, galvanized
- With opening bracket, steel, black
- Without locks
- Weight = 0.197 kg/piece

Applications

- For profiles 45
- Locking of doors and lids in guard units

Assembly

- Drill hole $\varnothing 22$ mm in the centre of the profile recommended: anti-twist protection F **part no.. 210941/0**
- To ensure the torsion protection, a pocket with SW 20.1 mm can alternatively be milled
- Tighten using front handle from the back side with the fastening nut