

CONNECTING SHAFT 90 - TWO-PIECE DIMENSION

Code: 171706/1

Connecting Shaft 90 for reliable motion transmission between two parallel linear guides. Suitable for longer shafts with additional support.

[Link to the product →](#)

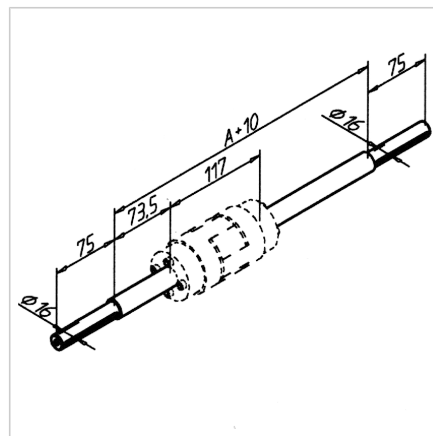
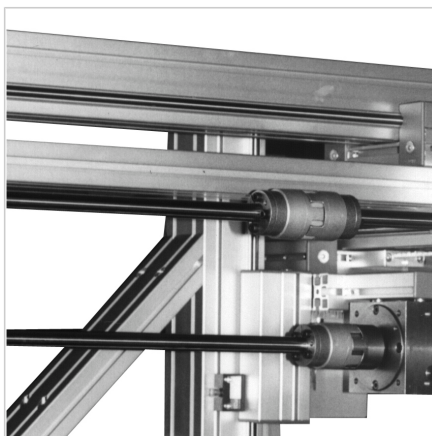

Technical data/items supplied

- Steel shaft $\varnothing 20$ mm
- 2 pieces, clutch not included
- With fastening material and feather key
- Length A = light distance between timing belt pulleys
- **Please indicate distance A**
- Other lengths and finishes available upon customer request
- Weight = 2,47 kg/m

Applications

- Simultaneous transmission of 2 parallel linear guides
- Install support bearing for longer shafts

Assembly

- Push the shafts with the feather key and the pressure plate into the timing belt reverse unit and secure with the pressure plate and the countersunk screw included
- Connect both shaft pieces with clutch **part no. 280180/0**