

END CAP 180X32 GREY

Code: 221059/1

Profile end cap 180 x 32. Plastic end cap for sealing and protecting aluminium profile edges. Easy installation and reliable protection.

[Link to the product →](#)

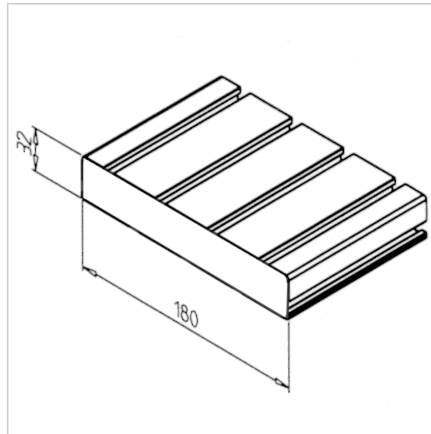

Technical data/items supplied

- ABS, Injection Mould, grey
- Weight = 0.020 kg/piece

Applications

- Mouth-side covering of profile ends of profile series 45