

END CAP 45 R 60° Z GREY

Code: 221018/1

Profile end cap 45 R 60°. Plastic end cap for sealing and protecting aluminium profile edges. Easy installation and reliable protection.

[Link to the product →](#)

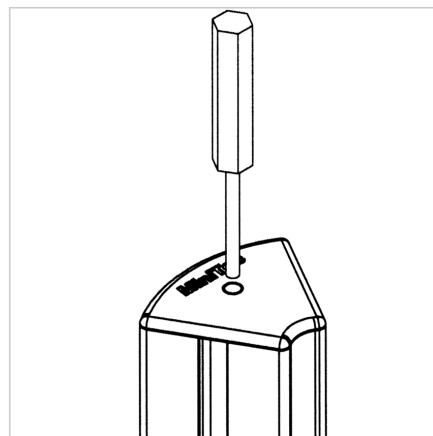
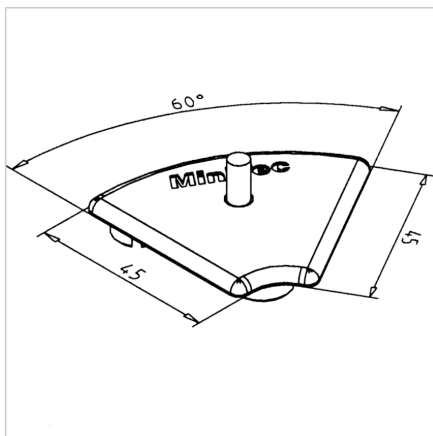

Technical data/items supplied

- ABS, Injection Mould, grey
- Weight = 0.006 kg/piece

Applications

- Mouth-side covering of profile ends of profile series 45

Assembly

- Insert profile cap
- Use rubber hammer to drive in lock pin flush with the profile
- To dismantle, knock through the pin with a 4mm pin
- Spare pin set Part No. [221009/1](#) is required for reuse