

## END CAP 45X180 GREY

Code: 221048/1

Profile end cap 45 x 180. Plastic end cap for sealing and protecting aluminium profile edges. Easy installation and reliable protection.

[Link to the product →](#)

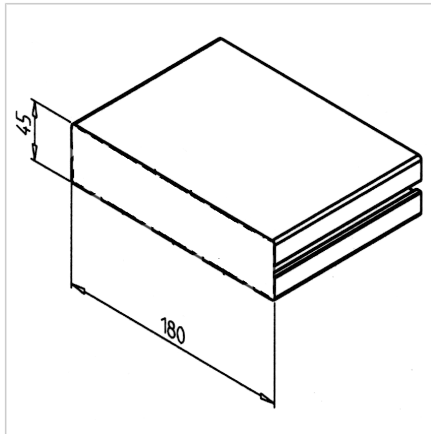

### Technical data/items supplied

- ABS, Injection Mould, grey
- Weight = 0.025 kg/piece

### Applications

- Mouth-side covering of profile ends of profile series 45