

END CAP 60X60 GREY

Code: 221057/1

Profile end cap 60 x 60. Plastic end cap for sealing and protecting aluminium profile edges. Easy installation and reliable protection.

[Link to the product →](#)

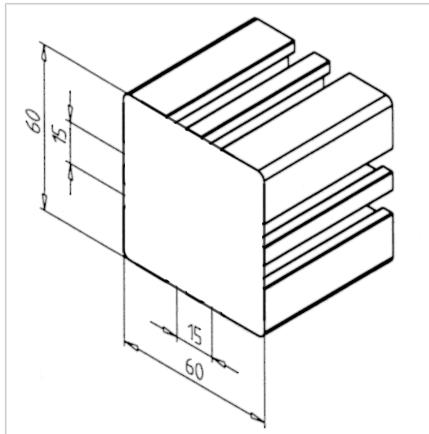
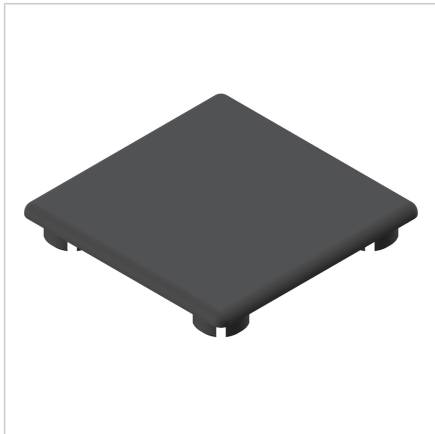

Technical data/items supplied

- ABS, Injection Mould, grey
- Weight = 0.010 kg/piece

Applications

- Mouth-side covering of profile ends of profile series 45