

END CAP LB 45X180 GREY

Code: 280102/1

End cap LB 45 x 180 provides a neat and secure closure for the linear slide and shaft support block on the shaft side.

[Link to the product →](#)

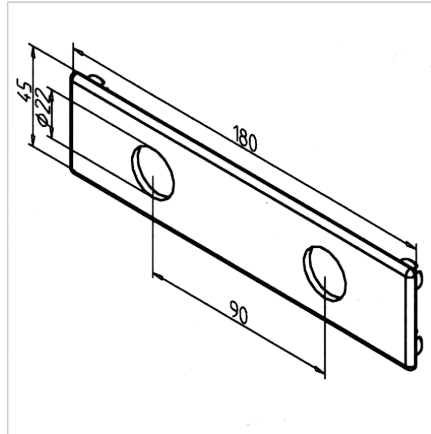

Technical data/items supplied

- ABS, Injection Mould, grey
- Aging and oil resistant
- On request also available in black, **part no. 280102/0**
- 2 bores \varnothing 22 mm
- Weight = 0.010 kg/piece

Applications

- Press the fastening pins into the profile holes

Assembly

- Front slide cover LB 45 x 180
- Front cover of shaft support blocks WB 45 x 180