

## END CAP LB 90 BLACK

Code: 280095/0

End cap LB 90 in black provides a neat and secure closure for the linear slide and shaft support block on the shaft side.

[Link to the product →](#)

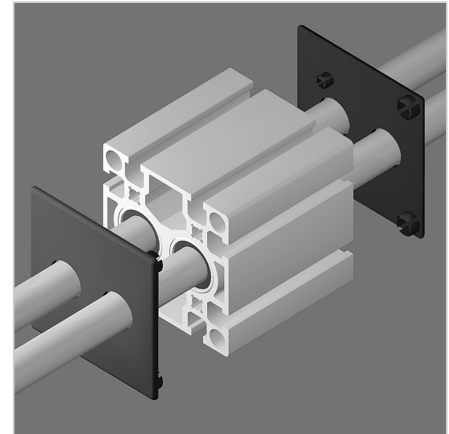
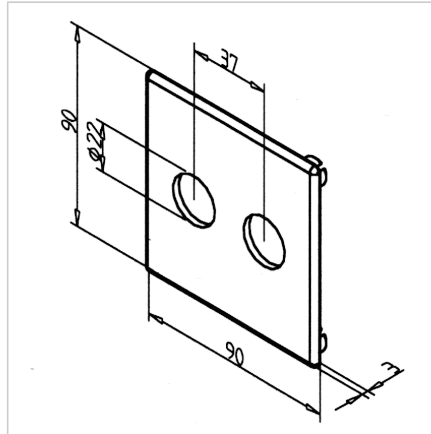
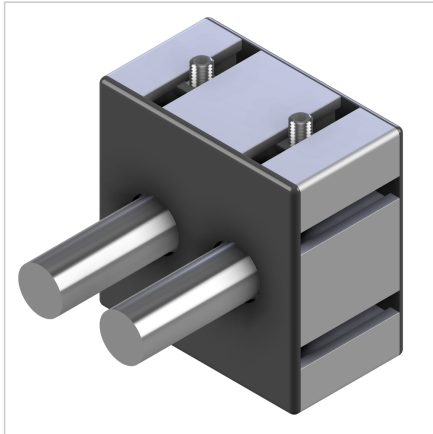

### Technical data/items supplied

- ABS, Injection Mould, black
- Aging and oil resistant
- 2 bores  $\varnothing$  22 mm
- Weight = 0.018 kg/piece

### Applications

- Press the fastening pins into the profile holes

### Assembly

- Front slide cover LB 90
- Front cover of shaft support blocks WB 90