

FB-FASTENING KIT LR 90

Code: 333011/0

Fastening kit for LR 90 for quick and reliable attachment of the protective cover to linear guides.

[Link to the product →](#)

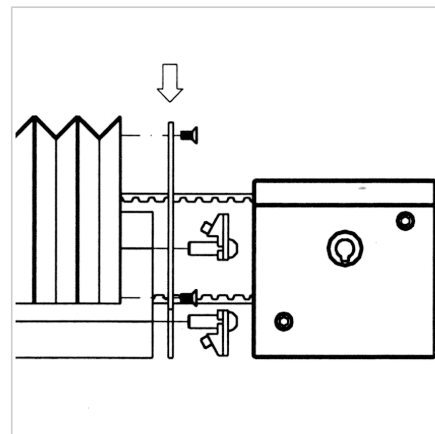
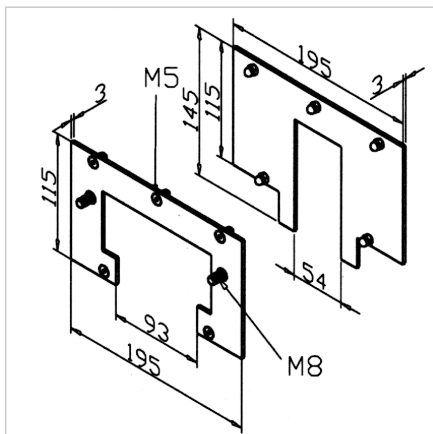
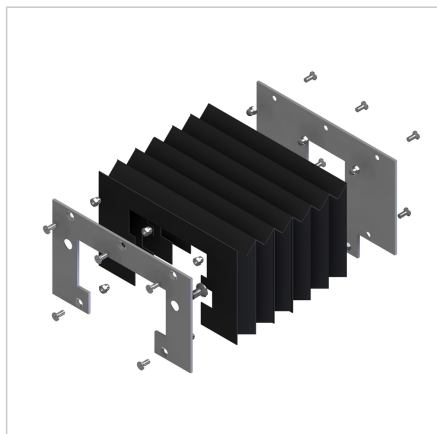

Technical data/items supplied

- Aluminium, anodized E6/EV1
- 1 End frame slide
- 1 End frame pulley
- Fastening kit for frame and bellow
- Weight = 0.750 kg/piece

Applications

- Fastening bellows LR 90 to carriages LW 90
- Fastening bellows LR 90 to timing belt reversing unit LW 90

Assembly

- Fasten end frame on slide
- Push bellow onto rail
- Loosen power-lock fastener on the pulley side and insert end frame pulley between rail and timing belt pulley; tighten power-lock fastener
- Fasten protective bellow by means of the supplied screws on the end frame