

FOOT ESD M10 D80 L=75

Code: 321022/0

Adjustable foot M10 D80 L=75 with ESD protection for stable and secure fastening of aluminium structures in ESD-sensitive industrial environments.

[Link to the product →](#)

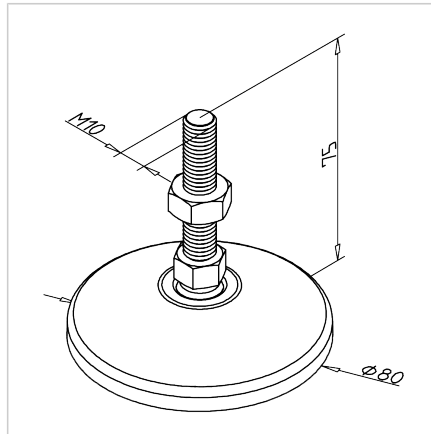

Technical data/items supplied

- Plate PA, black
- Anti-slip insert
- Spindle steel, galvanized
- Counter nut, steel, zinc plated
- Conductive
- Max. load capacity: 900 kg
- Weight = 0.123 kg/piece

Applications

- Height adjustable constructions of all kinds
- Protective equipment, tables, showcases
- Conveyors, system workstations

Assembly

- Directly in the central bore of the profile (can be drilled with thread up to M12)
- Larger threads in connection with connection plate
- For threads larger than M12, the hinged feet must be mounted in conjunction with the connection plate
- For profiles 45 x 90 and 90 x 90 a base and transport plate is required, if the feet are to be positioned centrally.