

LAMELLAR PLUG 9 GREY

Code: 221201/1

Lamellar plug 9 for sealing and finishing aluminium profile holes. Easy to install, durable and suitable for industrial use.

[Link to the product →](#)

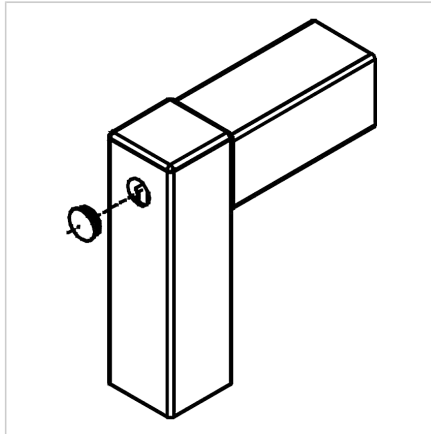
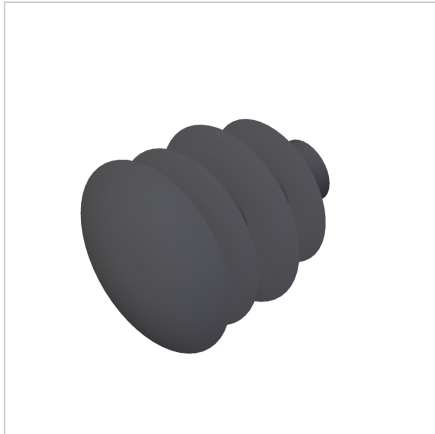

Technical data/items supplied

- PE, grey
- Weight = 0.001 kg/piece

Applications

- For closing off holes with \varnothing 9 mm, particularly in closed G-profiles