

LATERAL GUIDE 70 SUPPORT S

Code: 295056/0

[Link to the product →](#)

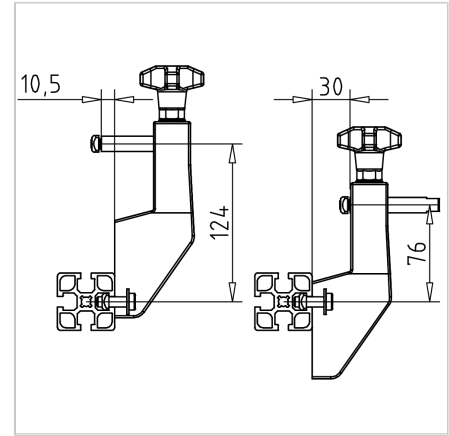
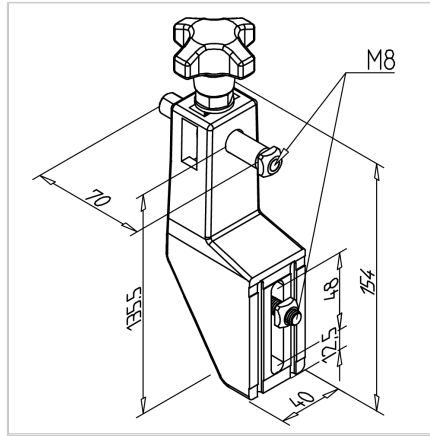

Technical data/items supplied

- PA, grey
- With fastening material steel, zinc plated
- Distance bolt, stainless steel
- Weight = 0.288 kg/piece

Applications

- Adjustable lateral guides for MiniTec belt conveyors
- Recommended distance from single holder approx. 500 mm

Assembly

- Set the height and tighten the screws
- Install lateral guidance, lateral guidance F or lateral guidance 40F
- Adjust lateral distance bolt