

LINEAR AXIS LR16 - 45X90 COMPLETE STROKE = MM

Code: 280802/0

Linear guides LR 16 - 45x90 stainless steel for precise motion with minimal friction. Assembled linear axis ready for immediate use.

[Link to the product →](#)

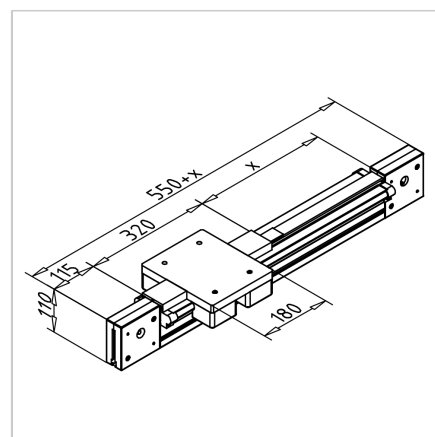
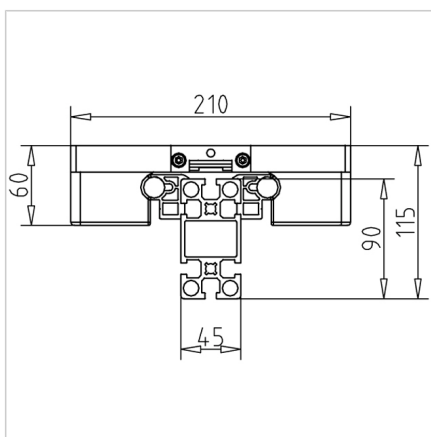

Technical data/items supplied

- Linear guide, ready for use, consisting of:
- 1x rail LR 16 - 45x90 with shaft fixation
- 2x timing belt pulley T90
- 2x timing belt tensioner
- 1x slide LR16-45
- 1x timing belt 32AT10
- **Please specify stroke length X and reverse unit**
- Weight = (basic weight) 10.19 kg
- Extra weight = 0.908 kg / 100 mm stroke

Applications

- Handling devices
- Measuring devices
- Calibration devices

Assembly

- Belt is fastened and tensioned with the aid of timing belt tensioner