

MINI-ADJUSTING UNIT WITH PROFILE 19X32

Code: 280351/0

Mini adjusting unit with 19x32 profile is ideal for adjusting lateral guides on conveyors, sensor holders, light barriers, and simple equipment.

[Link to the product →](#)

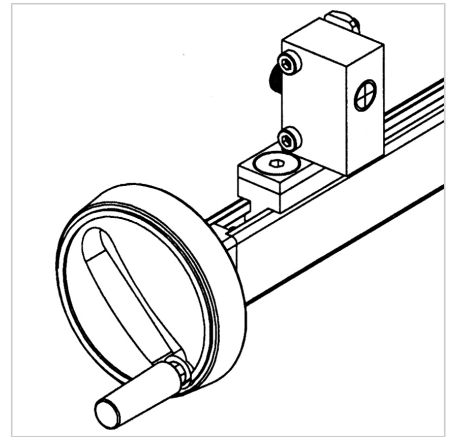
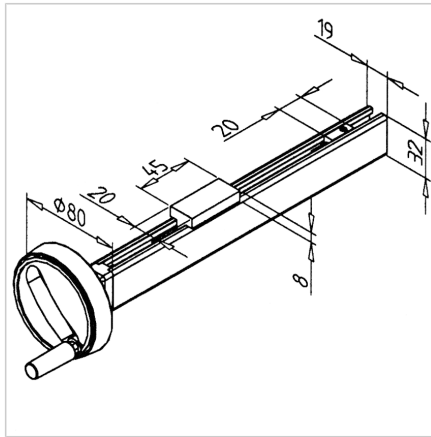

Technical data/items supplied

- With carrier profile 19 x 32
- VA spindle M8 x 1.25
- Brass slide
- Max. load 1 - 2 kg
- **Please indicate desired length of stroke**

Applications

- For adjustment of the lateral guides on conveying equipment
- For adjusting sensor holders or light barriers
- For simple equipment

Assembly

- With MiniTec power-lock fastener
- Can also be fastened with a mounting bracket
- Also available without carrier profile, **part no. 280351/1**