

PAN HEAD SCREW M6X20

Code: 211246/1

Pan head screw M6 x 20 made of steel for strong and reliable fastening of aluminium profiles and components.

[Link to the product →](#)

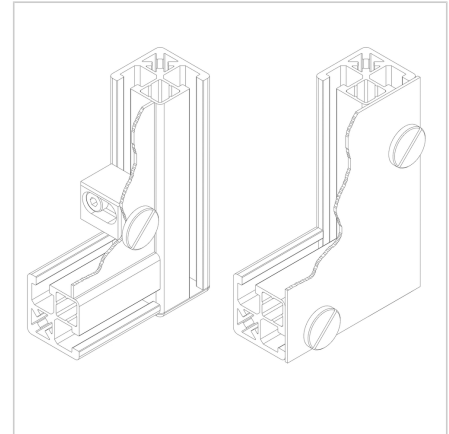
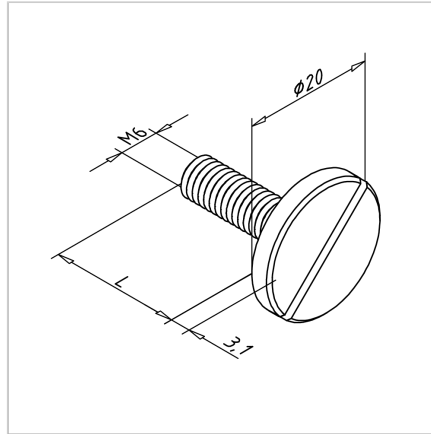

Technical data/items supplied

- Steel, galvanized
- Thread (d) : M 6
- Length (l) : 20 mm
- Head diameter ϕ 20 mm
- Weight = 0.010 kg/piece

Applications

- Assembly of surface elements directly on profile groove
- In connection with screw blocks, multiblocks and thread socket

Assembly

- Pre-drill surface elements: ϕ 6.5 mm
- Recommended grid dimensions: approx. 150 mm
- Edge distance: see screw block 32 and multi-block