

PANEL CLAMP BLOCK 45

Code: 221240/0

[Link to the product →](#)

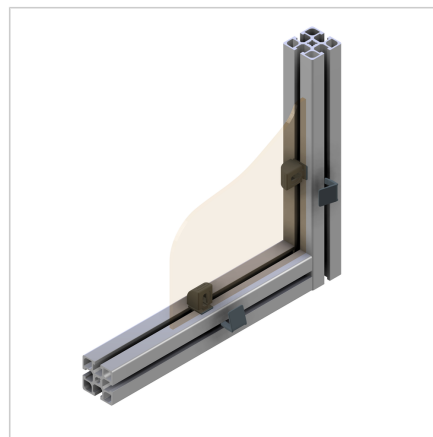
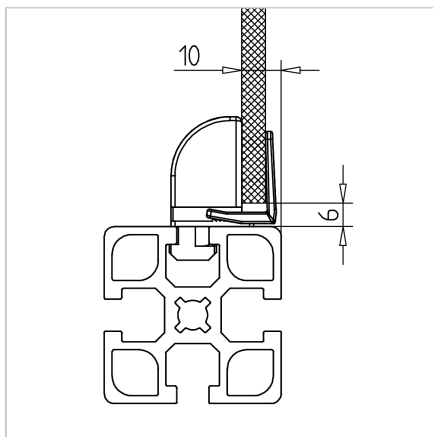
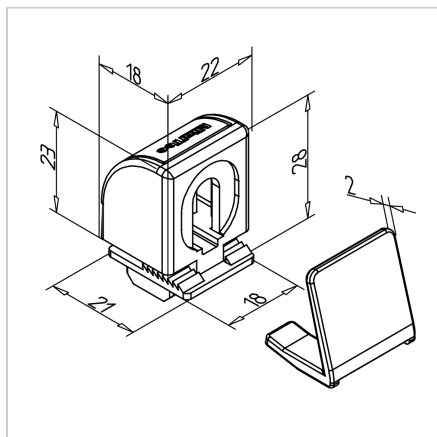

Technical data/items supplied

- ABS, Injection Mould, grey
- Weight = 0.008 kg/piece

Applications

- Suitable for profile series 45
- Retrofitting surface elements 2 mm to 6 mm thickness
- Circulating air gap 6 mm

Assembly

- Insert socket into profile groove
- Insert surface elements
- Press on clip
- **Dismounting:** Lift snap-in clip slightly and pull it out