

## PNEUMATIC CONNECTION PLATE 45X90 G1/4"

Code: 241105/2

Pneumatic base plate 45x90 with G1/4" thread for easy mounting and connection of pneumatic components in profile systems.

[Link to the product →](#)

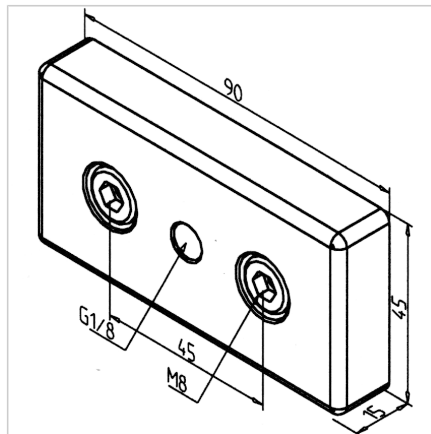

### Technical data/items supplied

- Aluminium, Pressure die-casting, powder-coated, grey
- With sealing plate of NBR, black
- Fastening kit
- Weight = 0.178 kg/piece

### Applications

- Closure of the hollow chamber ends of profiles 45 x 90 for connection of pneumatic connections

### Assembly

- Insert sealing plate
- Use fastening material included to screw into 2 central holes  $\varnothing$  7.5 mm (tightening torque 12 Nm)