

PROFILE 16X30

Code: 200983/0

Alu profile 16 x 30 for industrial use. Explore our aluminium profile system - strong, modular, and easy to assemble.

[Link to the product →](#)

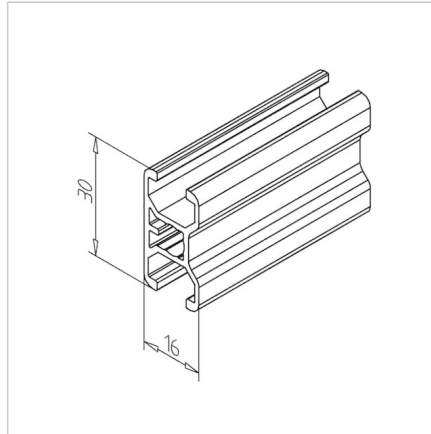
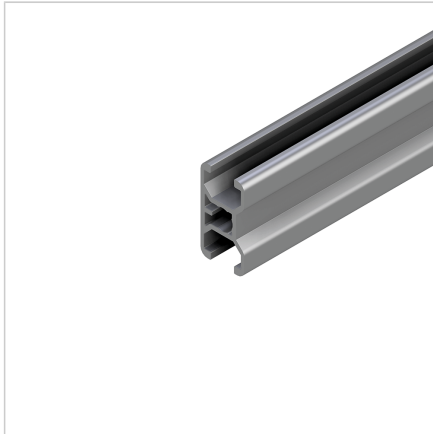

Technical data/items supplied

- Aluminium, extruded, anodized E6/EV1
- $I_x = 1.008 \text{ cm}^4$
- $I_y = 0.479 \text{ cm}^4$
- $w_x = 0.672 \text{ cm}^3$
- $w_y = 0.544 \text{ cm}^3$
- $IT = 1.488 \text{ cm}^4$
- Weight = 0.382 kg/m
- Bar length = 6 m
- Packing unit = 72 m

Applications

- Light constructions with protective hoods, covers, etc.

Assembly

- Power-lock fastener 30 / N 30
- Mitre connector 30
- Screw connection 30
- Angle 16
- Attaching accessories with sliding nut 30
M4 / M5 / M6 / M8