

## PROFILE 19X19

Code: 201075/0

Alu profile 19 x 19 for industrial use. Explore our aluminium profile system - strong, modular, and easy to assemble.

[Link to the product →](#)

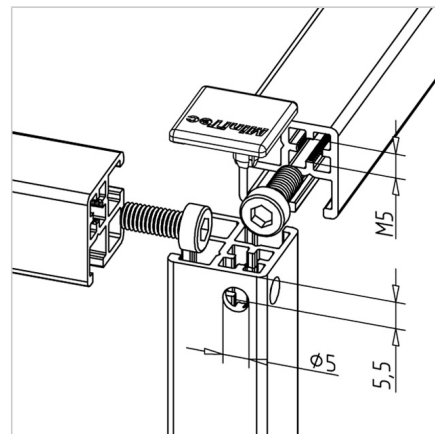
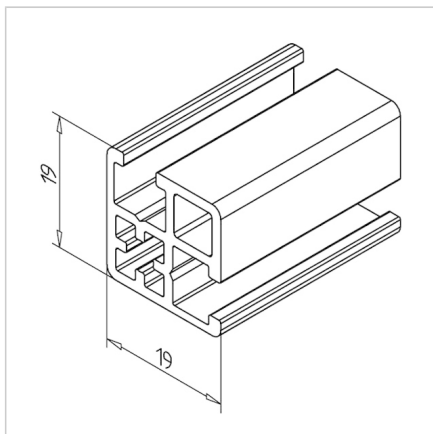

### Technical data/items supplied

- Aluminium, extruded, anodized E6/EV1
- $I_x = 0.57 \text{ cm}^4$
- $I_y = 0.57 \text{ cm}^4$
- $w_x = 0.543 \text{ cm}^3$
- $w_y = 0.543 \text{ cm}^3$
- $IT = 1.029 \text{ cm}^4$
- Slot dimension and core hole for thread M5
- Weight = 0.460 kg/m
- Bar length = 6 m

### Applications

- Small guards and constructions in which very small profiles are required
- Suitable end cap, grey **article no. 221031/1**

### Assembly

- Screw connector 11, **Art.-Nr. 211574/1**
- Square nut M5 for profile series MINI **part no. 211382/0**