

PROFILE 30X30 1G

Code: 201139/0

Alu profile 30 x 30 1G for industrial use. Explore our aluminium profile system – strong, modular, and easy to assemble.

[Link to the product →](#)

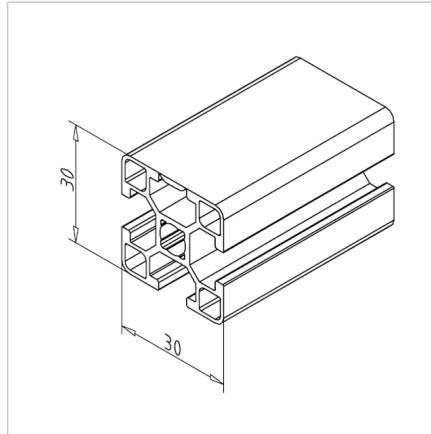
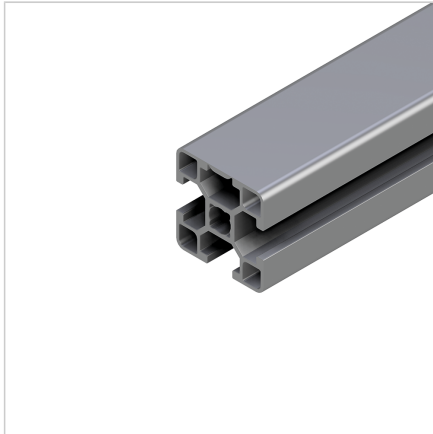

Technical data/items supplied

- Aluminium, extruded, anodized E6/EV1
- $I_x = 2.311 \text{ cm}^4$
- $I_y = 2.112 \text{ cm}^4$
- $w_x = 1.481 \text{ cm}^3$
- $w_y = 1.408 \text{ cm}^3$
- $IT = 4.423 \text{ cm}^4$
- Weight = 0.670 kg/m
- Bar length = 6 m
- Packing unit = 54 m

Applications

- Light constructions with protective hoods, covers, etc.
- Specifically for high hygiene requirements in the food industry, medical technology, bottling of beverages

Assembly

- Power-lock fastener 30 / N 30
- Mitre connector 30
- Screw connection 30
- Angle 16 / 30
- Attaching accessories with sliding nut 30 M4 / M5 / M6 / M8