

## PROFILE 30X30

Code: 201068/0

Alu profile 30 x 30 for industrial use. Explore our aluminium profile system - strong, modular, and easy to assemble.

[Link to the product →](#)

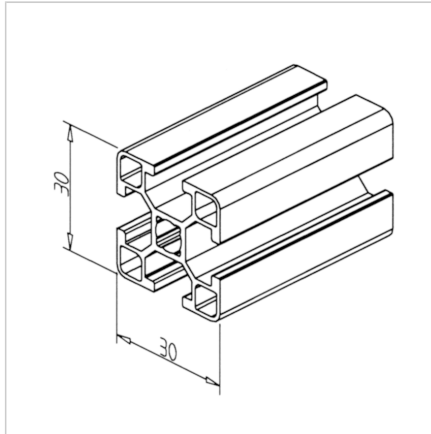
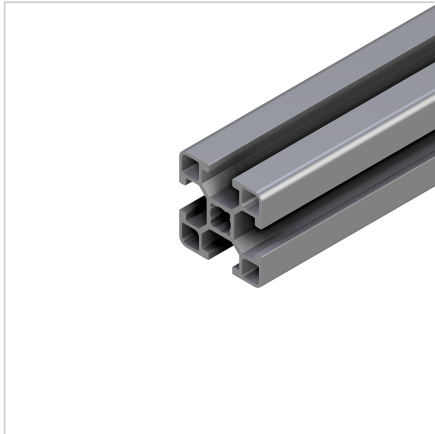

### Technical data/items supplied

- Aluminium, extruded, anodized E6/EV1
- $I_x = 2.133 \text{ cm}^4$
- $I_y = 2.133 \text{ cm}^4$
- $w_x = 1.422 \text{ cm}^3$
- $w_y = 1.422 \text{ cm}^3$
- $IT = 1.036 \text{ cm}^4$
- Weight = 0.652 kg/m
- Bar length = 6 m
- Packing unit = 54 m

### Applications

- Light constructions with protective hoods, covers, etc.

### Assembly

- Power-lock fastener 30 / N 30
- Mitre connector 30
- Screw connection 30
- Angle 16 / 30
- Attaching accessories with sliding nut 30 M4 / M5 / M6 / M8