

## PROFILE 30X60

Code: 200994/0

Alu profile 30 x 60 for industrial use. Explore our aluminium profile system - strong, modular, and easy to assemble.

[Link to the product →](#)

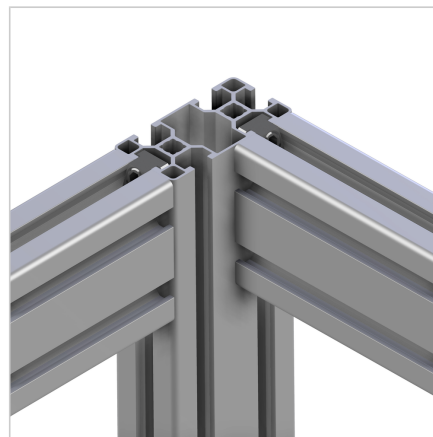
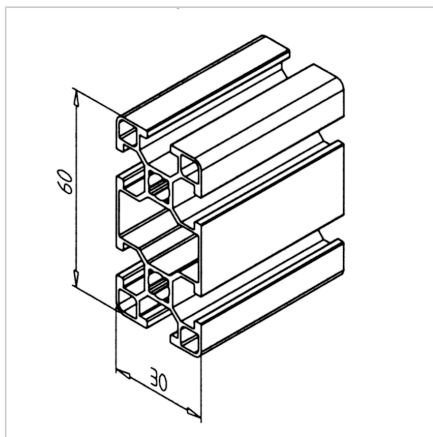
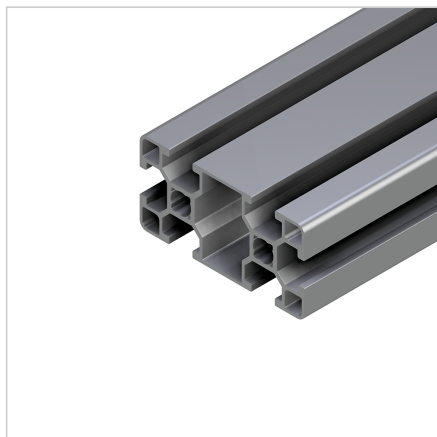

### Technical data/items supplied

- Aluminium, extruded, anodized E6/EV1
- $I_x = 14.898 \text{ cm}^4$
- $I_y = 3.792 \text{ cm}^4$
- $w_x = 4.966 \text{ cm}^3$
- $w_y = 2.528 \text{ cm}^3$
- $IT = 7.192 \text{ cm}^4$
- Weight = 1.069 kg/m
- Bar length = 6 m
- Packing unit = 54 m

### Applications

- Light constructions with protective hoods, covers, etc.

### Assembly

- Power-lock fastener 30 / N 30
- Mitre connector 30
- Screw connection 30
- Angle 16 / 30
- Attaching accessories with sliding nut 30 M4 / M5 / M6 / M8