

PROFILE 45X45 3G

Code: 201048/0

Alu profile 45 x 45 3G for industrial use. Explore our aluminium profile system – strong, modular, and easy to assemble.

[Link to the product →](#)

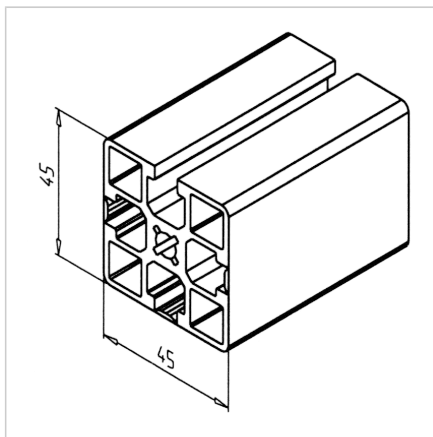
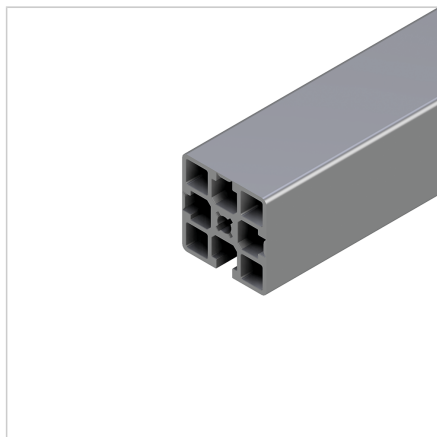

Technical data/items supplied

- Aluminium, extruded, anodized E6/EV1
- $I_x = 13.554 \text{ cm}^4$
- $I_y = 14.049 \text{ cm}^4$
- $w_x = 5.941 \text{ cm}^3$
- $w_y = 6.244 \text{ cm}^3$
- $IT = 43.247 \text{ cm}^4$
- Weight = 1.953 kg/m
- Bar length = 6 m
- Packing unit = 36 m

Applications

- All types of constructions, specifically for high hygiene requirements in the food industry, medical technology, bottling of beverages
- To close open grooves with the cover profile L **part no. 201021/0**
- Silicon sealings for profile connections on request

Assembly

- Power-lock fastener; to use, the groove cover at the end of the profile must be opened using the groove opener. Cover with end cap G **Art. no. 221056/0**
- Angle 25 / 45
- Closed grooves can be opened with the groove opener **part no. 260815/0** to the desired length