

PROFILE 45X60 F

Code: 201023/0

Alu profile 45 x 60 F for industrial use. Explore our aluminium profile system - strong, modular, and easy to assemble.

[Link to the product →](#)

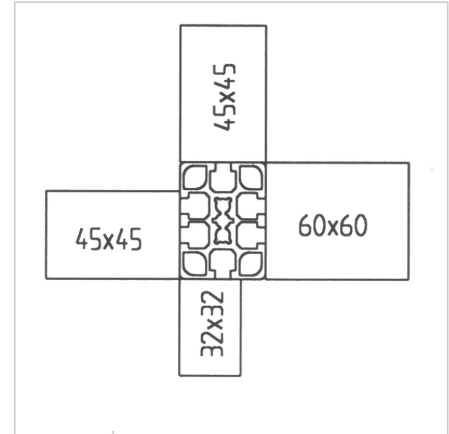
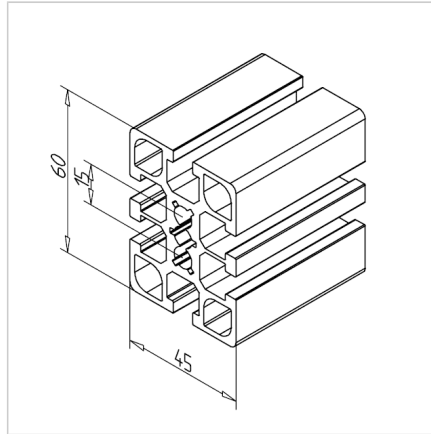
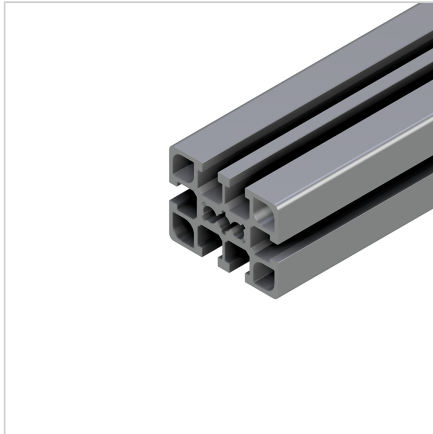

Technical data/items supplied

- Aluminium, extruded, anodized E6/EV1
- $I_x = 32.068 \text{ cm}^4$
- $I_y = 17.587 \text{ cm}^4$
- $w_x = 10.689 \text{ cm}^3$
- $w_y = 7.816 \text{ cm}^3$
- $IT = 19.050 \text{ cm}^4$
- Weight = 2.603 kg/m
- Bar length = 6 m
- Packing unit = 24 m

Applications

- All kinds of constructions
- Corner posts in large safety devices

Assembly

- MiniTec power-lock fastener
- Angle 19 / 25 / 45 / 45 x 90 GD-Z
- Central boring for thread M8