

ROTATION DIRECTION ROD LOCK 32, WITH LOCK, 2 RODS

Code: 211798/6

2-point rod lock with cylinder lock for secure closure of profile 32 doors in enclosures and safety systems.

[Link to the product →](#)

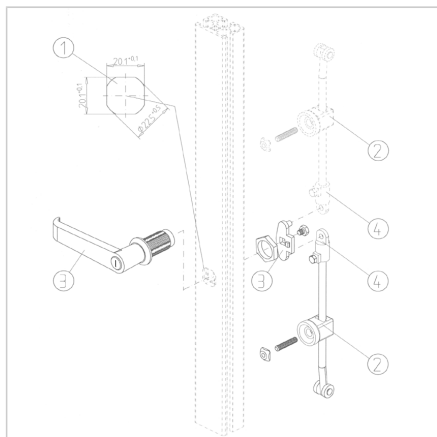

Technical data/items supplied

- Handle without lock
- Bar retainer made of steel, galvanised
- Overrun rod with rollers (L = 1100 mm), steel, galvanised
- Rod guide, black plastic with injected nut M6
- Weight = 1.217 kg/piece

Applications

- For locking doors at the top or bottom cross-rail
- Particularly suitable for control cabinets and double-leaf doors

Assembly

- Insert square recess into vertical door profile
- Screw setscrew M6 x 30 into rod guide, screw nut loosely onto setscrew, insert square nut into groove and tighten rod guide in position. Screw cam latch onto cam lock or handle. Insert the overrun rod into the rod guide and fix it on the cam latch