

SLIDE LWG 32X45-90 WITH CLAMPING DEVICE AT TOP

Code: 280133/1

Linear carriage LWG 32 x 45 series 90 with top clamping unit allows precise adjustment and reliable locking in aluminum profile constructions.

[Link to the product →](#)

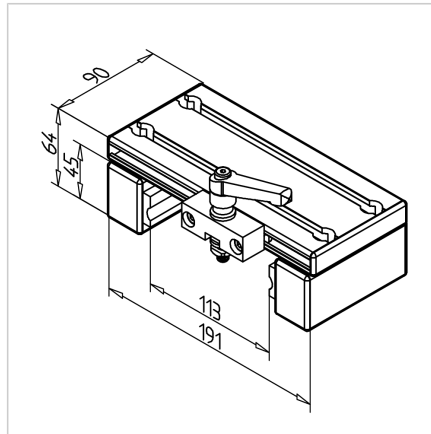
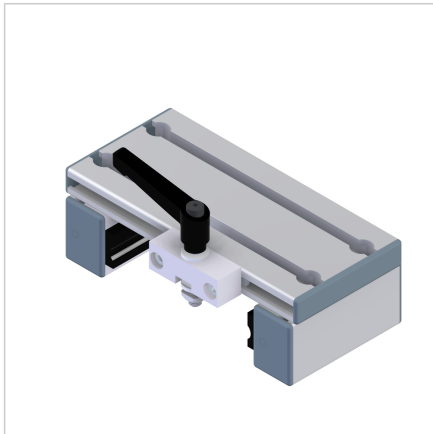

Technical data/items supplied

- Aluminium, anodized E6/EV1
- End caps
- Clearance adjusted
- Weight = 1.009 kg/piece

Applications

- Simple linear guides
- Slide units
- For rail 90 with shafts \varnothing 12 mm

Other versions

- Different slide lengths