

## SLIDE LWN 45/45°-45

Code: 280196/0

Linear carriage LWN 45/45° series 45 ensures precise and smooth linear motion in aluminum profile constructions.

[Link to the product →](#)

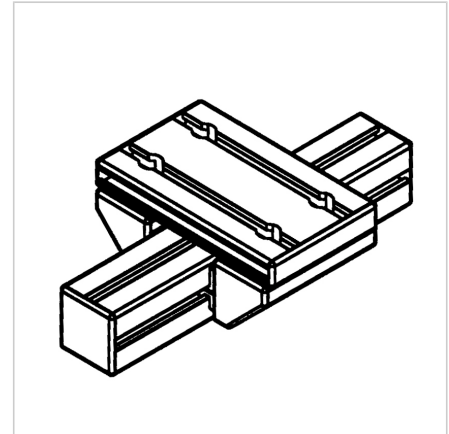
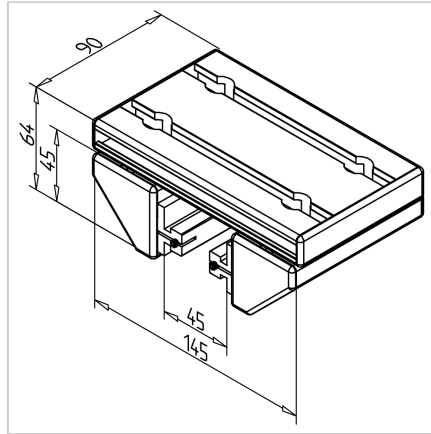
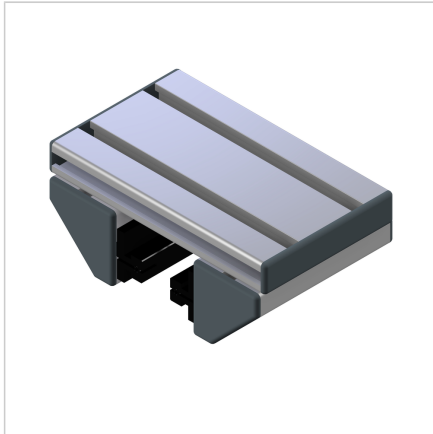

### Technical data/items supplied

- Aluminium, anodized E6/EV1
- Fully mounted carriage
- 2 slide rails LN
- End caps
- Load capacity up to 450 N
- Clearance adjusted
- Weight = 0.699 kg/piece

### Applications

- Simple linear guides
- Slide units

### Other versions

- With slide clamping device at top **part no. 280196/1**
- Different slide lengths