

## SLIDE LWN 45/45°-90 WITH CLAMPING DEVICE AT TOP

Code: 280197/1

Linear carriage LWN 45/45° series 90 with top clamping unit allows precise adjustment and reliable locking in aluminum profile constructions.

[Link to the product →](#)

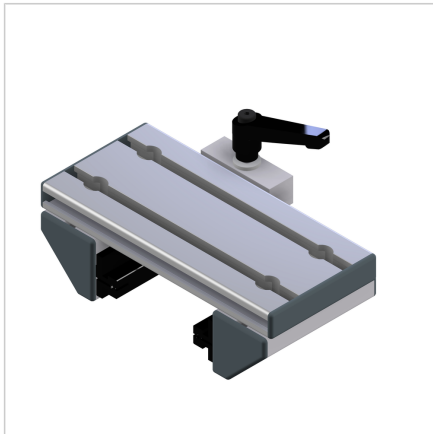

### Technical data/items supplied

- Aluminium, anodized E6/EV1
- Fully mounted carriage
- 2 slide rails LN
- End caps
- Clearance adjusted
- Weight = 0.981 kg/piece

### Applications

- Simple linear guides
- Slide units

### Other versions

- Different slide lengths