

SQUARE-NUT M4 WITH POSITION-FIXING

Code: 211310/2

Square nut M4 x 13 with position-fixing, designed for precise and secure fastening in aluminium profile systems. Prevents rotation for stable assemblies.

[Link to the product →](#)

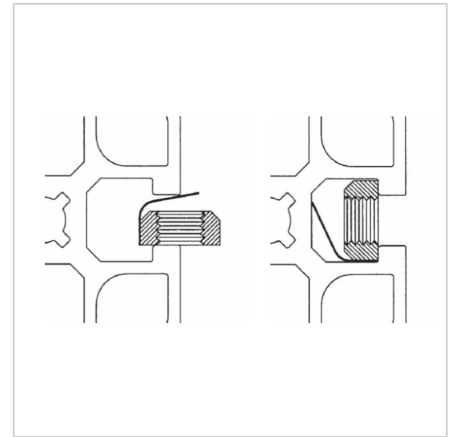
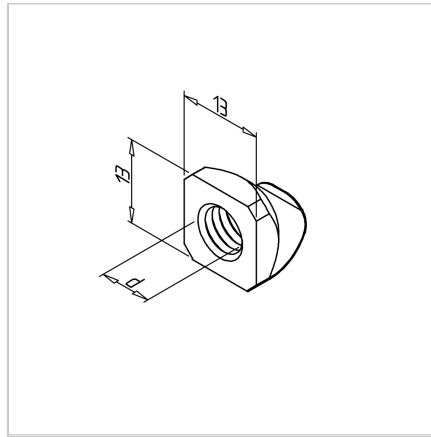
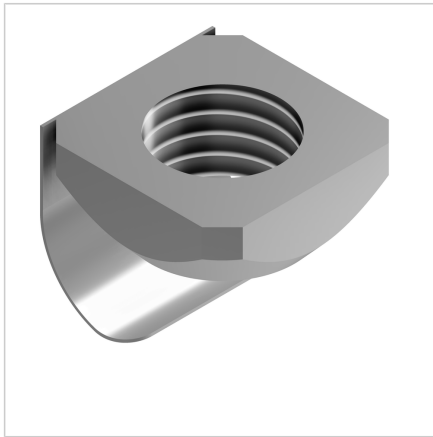

Technical data/items supplied

- Stainless steel
- Thread (d) : M 4
- Weight = 0.006 kg/piece

Applications

- Sliding nuts can be swiveled into the profile (series 45) at any point
- The spring plate holds the nut in the desired position

Assembly

- Mounting by swiveling into the groove