

SQUARE-NUT M6 H WITH POSITION FIXING

Code: 211330/4

Square nut M6 H with position fixing for precise and secure fastening in aluminium profile systems. Prevents rotation for stable and reliable assemblies.

[Link to the product →](#)

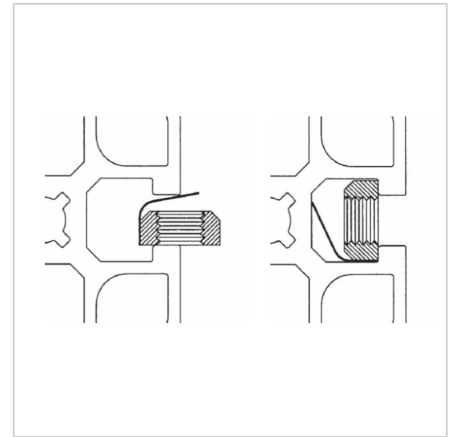
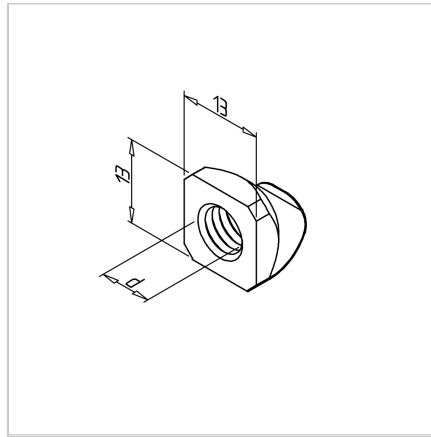
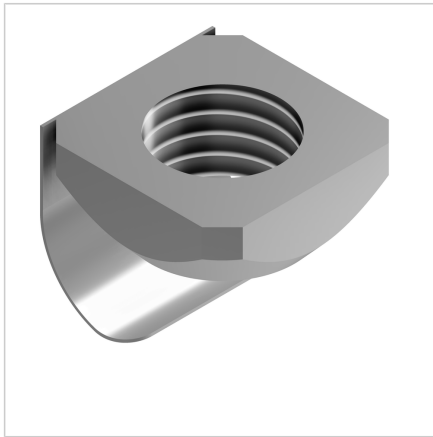

Technical data/items supplied

- Stainless steel
- Thread (d) : M 6
- Weight = 0.005 kg/piece

Applications

- Sliding nuts can be swiveled into the profile (series 45) at any point
- The spring plate holds the nut in the desired position

Assembly

- Mounting by swiveling into the groove