

SQUARE WASHER 6

Code: 211363/0

Square washer 6 for even force distribution when fastening aluminium profiles. Ensures stable connections and protects surface areas.

[Link to the product →](#)

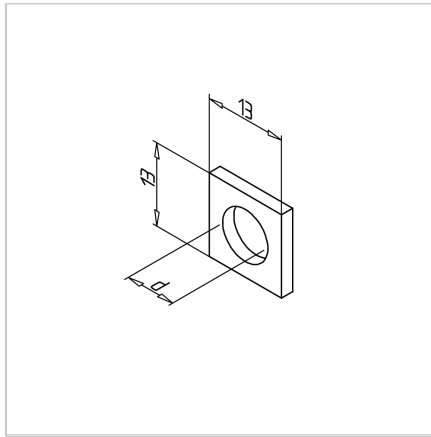
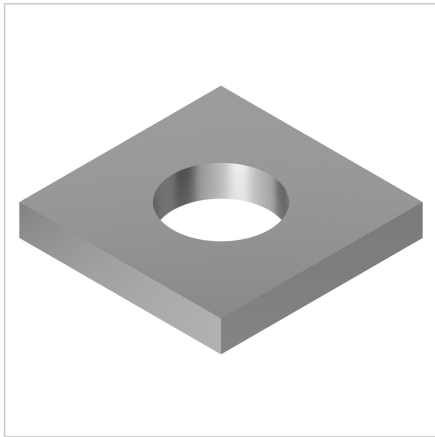

Technical data/items supplied

- Steel, galvanized
- Diameter (d) : 6.2 mm
- Weight = 0.002 kg/piece