

TIMING BELT PULLEY LR 6_14 FEATHER KEY 5 MM

Code: 280510/3

Timing belt end piece LR 6_14 for precise and reliable motion transmission in linear guides.

[Link to the product →](#)

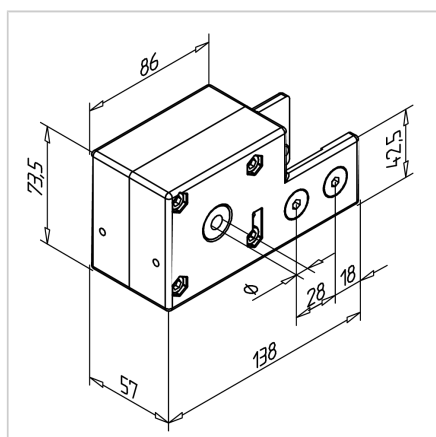
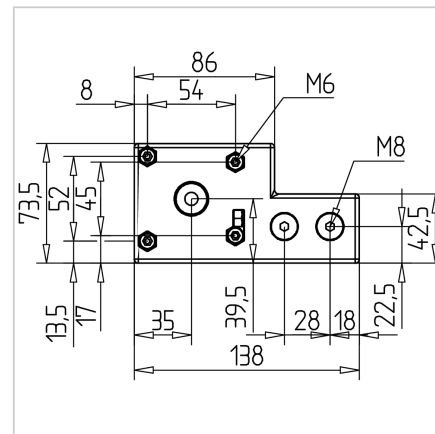
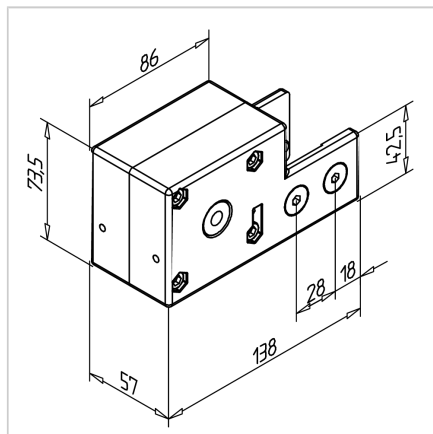

Technical data/items supplied

- Aluminium, Pressure die-casting, powder-coated, grey
- Connection elements, steel, galvanised
- Aluminium pulley with flanges made of stainless steel for timing belt 16AT5 36 teeth, effective diameter 57.3 mm
Timing belt length required within the return/reversing point 160 mm max. Torque 30 Nm
- Pulley with bore 14 mm and feather key groove 5 mm
- 2 ball-bearings
- Weight = 0.960 kg/piece

Applications

- For MiniTec linear guides LR 6 Z

Assembly

- Insert square nut M8 in rail and pre-position
- Guide the timing belt through the reverse unit
- Guide the pulley on rail end
- Pre-assemble fastening screws
- Fix timing belt on slide
- Tighten at pulley using hex Allen key SW3
- Tighten fastening screws