

## TIMING BELT PULLEY T90 \_19 FEATHER KEY 6 MM

Code: 280082/5

Timing belt end piece T90 \_19 ensures precise and reliable motion transmission in linear guides.

[Link to the product →](#)

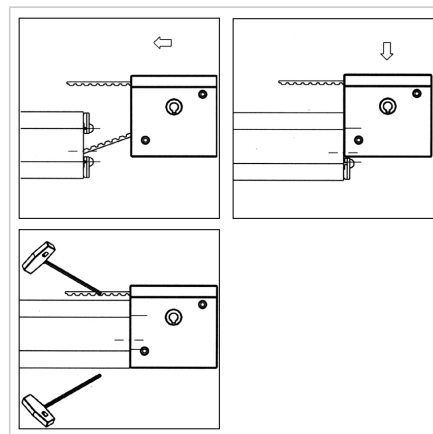
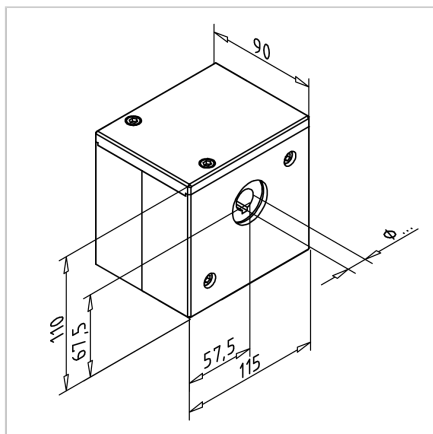

### Technical data/items supplied

- Housing 3-piece, anodized aluminum
- Connection elements, steel, galvanised
- Aluminum pulley with stainless steel flanges for timing belt 32AT10  
19 teeth, effective diameter 60.48 mm  
Required toothed belt length within the deflection 210 mm  
max. torque 130 Nm
- Pulley with bore 19 mm and feather key groove 6 mm
- 2 ball-bearings
- Weight = 2.800 kg/piece

### Applications

- All MiniTec linear guides

### Assembly

- Provide rails with thread M8 at both sides, screw in power-lock fastener **part no. 211018/0**
- Guide the timing belt through the reverse unit
- Insert pulley unit from top
- Tighten power-lock fastener
- Tighten the timing belt
- For mounting the corrosion-resistant version, use profile connector H **part no. 211018/1**