

TIMING BELT REVERSE UNIT T45 _11 STAINLESS

Code: 280615/2

Timing belt end piece T45 _11 stainless for precise and reliable motion transmission in linear guides.

[Link to the product →](#)

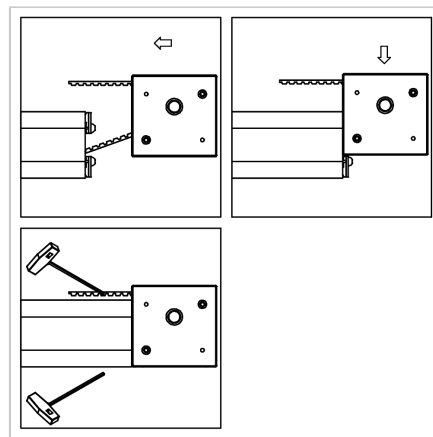
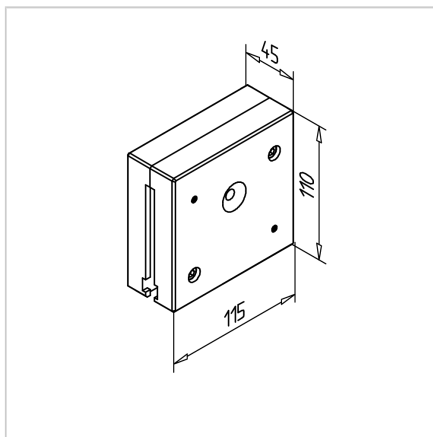

Technical data/items supplied

- Housing 2-piece, anodized aluminum
- Connecting elements in stainless steel
- Aluminum pulley with stainless steel flanges for timing belt 32AT10 19 teeth, effective diameter 60.48 mm Required toothed belt length within the deflection 210 mm max. torque 70 Nm
- Pulley with bore 11 mm and feather key groove 4 mm
- 2 ball-bearings
- Weight = 1.245 kg/piece

Applications

- All MiniTec linear guides

Assembly

- Make thread M8 in both ends of the rail, screw in power-lock fastener **part. no. 2111018/1**
- Guide the timing belt through the reverse unit
- Insert pulley unit from top
- Tighten power-lock fastener
- Tighten the timing belt